

Why CENTRO? | Warum CENTRO?

🇬🇧 CENTRO "Leading Innovative Display Future"

Represents the changing TREND in exhibition stands - totally professional, functional, eye-catching and affordable clients are surprised they can purchase a purpose built Centro exhibition displays for the cost of hiring big booth exhibition stands from a traditional custom exhibition company for one trade show only.

CENTRO Exhibiton Display is cost and time effective system if you compare with hired exhibiton stands which are utilized for one trade show only. CENTRO systems allow you numerous combinations of attention-getting looks and booth sizes and shapes and expanding your booth when you need.

Versatile

You can either choose one of our preconfigured structures for creating endless configurations to suit your needs. With its extension bars and locking mechanism it is up to you to decide the height, the width and shape of the units. You can design your stand linear, concave or convex shape. There is no limitation on the height and length.

Portable

A user friendly system. Very easy to install the system according to the assembly sheet using a single hex key pre-supplied in this bag. Easily transported in its own set of carry trolley bags.

Classic CENTRO, presents innovative trend in exhibition stands and booths with its additional components like new "T-Lock System" and new "Easy Lock Profile System". You can easily build your stand and booth in retails and trade shows.

Sturdy

Stability is achieved by 75 mm diameter aluminium posts and 6 mm thick galvanized steel base plates.

Elegant

8-way round posts, stylish base plates, neon acrylic end-caps and innovative accessory range. Elegancy and mobility combined in the same system.

Components & Accessories

Centro Modular Displays are composed of an aluminium extrusion skeleton with interchangeable fabric graphic panels and necessary accessories such as monitor brackets, shelves, brochure-holders etc.

Supporting Kits

Counters, Totem, Barriers, Storage Doors, Showcase, Slatwall, Wire Cable Displays and Console.

🇩🇪 CENTRO "Führende Innovative Display Zukunft"

Stellt die wechselnde TREND in Messeständen - total professionelle, funktionale, aufmerksamkeitsstarke und erschwingliche - Kunden sind überrascht, dass sie eine zweckgebaute Centro Messe Displays für die Kosten der Vermietung von großer Messestände aus einer traditionellen kundenspezifischen Messeausstatter für eine einzige Messe erwerben können

CENTRO Messe Display ist kosten- und zeitgesteuertes System, wenn Sie mit gemieteten Messeständen vergleichen, die nur für eine Messe genutzt werden. CENTRO-Systeme ermöglichen Ihnen zahlreiche Kombinationen von aufmerksamkeitsstarkem Schau und Standgrößen und Formen und erweitern Ihren Stand, wenn Sie es brauchen.

Vielseitig

Sie können entweder eine unserer vorkonfigurierten Strukturen wählen, um endlose Konfigurationen für Ihre Anforderungen zu erstellen. Mit den Verlängerungsstangen und dem Verriegelungsmechanismus können Sie die Höhe, die Breite und die Form der Einheiten bestimmen. Sie können Ihren Stand linear, konkav oder konvex gestalten. Es gibt keine Begrenzung der Höhe und Länge. Portable

Portable

Ein benutzerfreundliches System. Sehr einfach zu installieren das System nach dem Montageblatt mit einem einzigen Sechskantschlüssel mitgeliefert in der Tragetasche. Leicht transportiert in einer eigenen Tragetasche.

Classic CENTRO präsentiert innovativen Trend in Messeständen und Messeständen mit zusätzlichen Komponenten wie dem neuen "T-Lock System" und dem neuen "Easy Lock Profile System". Sie können Ihren Messe- und Ausstellungsstand ganz einfach in den Einzelhandel und Messen.

Robust

Stabilität wird erreicht durch 75 mm Durchmesser Aluminiumpfosten und 6 mm dicke verzinkte und beschichtete Stahlbodenplatten.

Elegant

8-fach runde Pfosten, stilvolle Basisplatten, Neon-Acryl-Endkappen und innovatives Zubehörprogramm. Eleganz und Mobilität kombiniert in demselben System.

Komponenten & Zubehör

Centro Modular Displays bestehen aus einem Aluminium-Extrusions skelett mit austauschbaren Graphikplatten und notwendigem Zubehör wie Monitorhalter, Regalböden, Prospekthalter etc.

Unterstützende Kits

Theken, Totem, Absperrungssystemen, Lagertüren, Schaukästen, Slatwall, Draht Kabel Displays und Konsole.



Patented

www.centrodisplay.com

How You Can Use CENTRO? | Wie können Sie CENTRO verwenden?



MAGNETIC PANELS

Suitable for single or double-sided flexible magnetic graphic panel drop(s)
Standart overall height without lighting 2021 mm

Maximum footprint (except space bars)
750mm 1004(w) x 380mm(d)
1500mm 1754(w) x 380mm(d)
2250mm 2504(x) x 380mm(d)

Maximum footprint with optional space bars
750mm 1224(w) x 380mm(d)
1500mm 1974(w) x 380mm(d)
2250mm 2724(x) x 380mm(d)

4mm hex key supplied or no tool system



BANNER

Suitable for banner media with horizontal pockets.
Standart overall height without lighting 2021 mm

Maximum footprint
750mm 1006(w) x 380mm(d)
1500mm 1756(w) x 380mm(d)
2250mm 2506(x) x 380mm(d)

4mm hex key supplied
Display hardware for both options fit within single trolley case
Graphic tube within trolley case can only accommodate banner graphic



RIGID PANELS

Suitable for rigid PVC, glass, MDF panels.
You can build what you want.
4mm hex key supplied
Display hardware for both options fit within trolley hard case



MAGNETISCHE PVC PANELE

Geeignet für einseitige oder doppelseitige, flexible magnetische Grafikpaneele
Standart Gesamthöhe ohne Beleuchtung 2021 mm

Maximale Außengröße (außer Abstandleisten)
750mm 1004 (B) x 380mm (T) 1500mm
1754 (B) x 380mm (T)
2250mm 2504 (B) X 380mm (T)

Maximale Abmessungen mit optionalem Abstandleisten
750mm 1224 (B) x 380mm (T)
1500mm 1974 (B) x 380mm (T)
2250mm 2724 (B) x 380mm (T)

4mm Inbusschlüssel geliefert oder ohne Werkzeugsystem

TEXTIL BANNER

Geeignet für Banner-Medien mit horizontalen Taschen.
Standart Gesamthöhe ohne Beleuchtung 2021 mm

Maximale Außengröße
750mm 1006 (B) x 380mm (T)
1500mm 1756 (B) x 380mm (T)
2250mm 2506 (B) x 380mm (T)

4mm Inbusschlüssel geliefert
Display-Hardware für beide Optionen passend in einer Trolleykoffer
Rohrgraphicträger in Trolley kann nur Banner-Grafik enthalten

STARKE PANEELE

Geeignet für PVC, Glas, MDF-Platten.
Sie können bauen, was Sie wollen.

4mm Inbusschlüssel
Display-Hardware für beide Optionen passend in einer Trolleykoffer

Classic System Component & Accessories

Classic Systemkomponenten und Zubehör

Indoor - Innenbereich

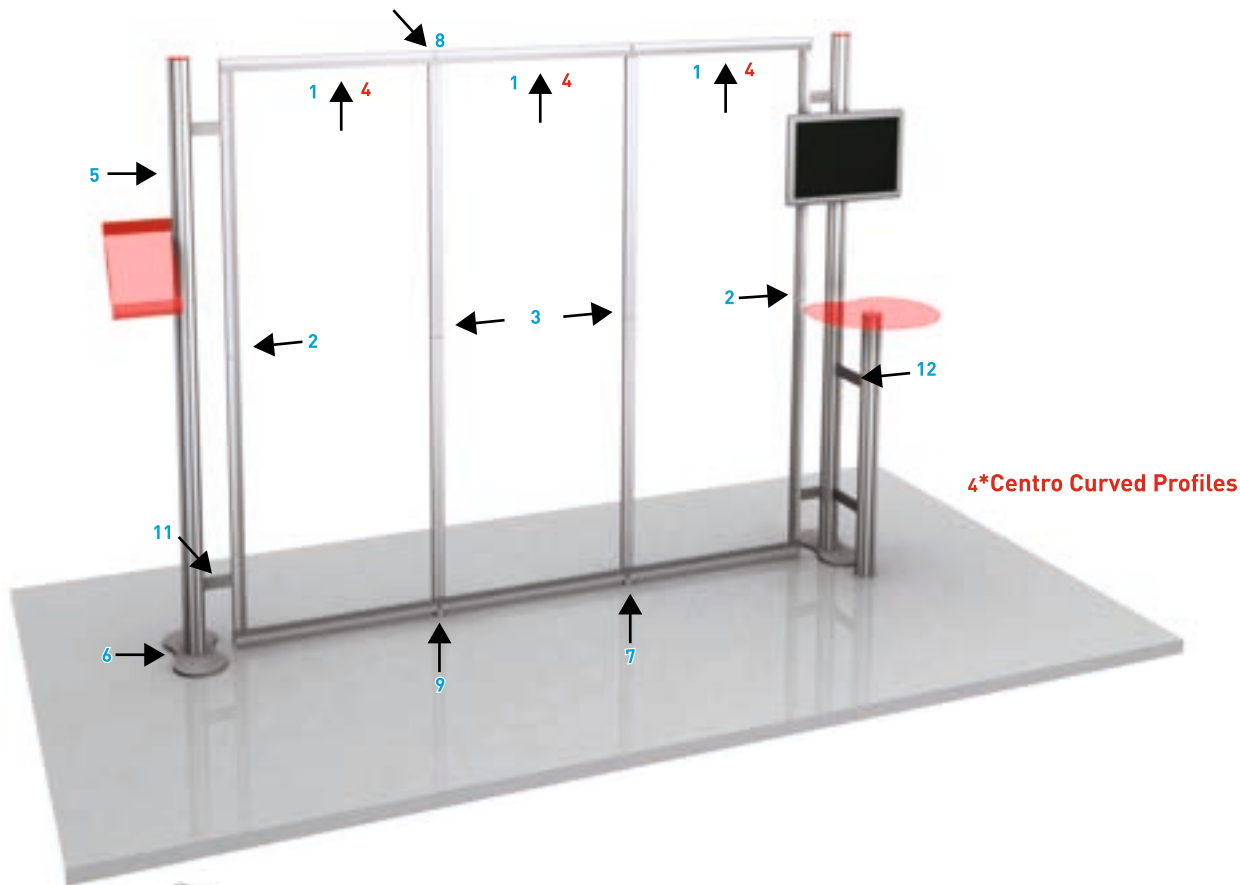

- | | | | |
|--|---|--|--|
| | 750 mm Horizontal beam straight with 1 run of steel tape.
<i>750 mm Horizontalstrahl gerade mit 1 Lauf aus Stahlband.</i> | | Adjustment tool for uneven floor.
<i>Einstellwerkzeug für unebenen Boden.</i> |
| | 950 mm Vertical beam straight with 1 run of steel tape.
<i>950 mm Vertikalstrahl gerade mit 1 Lauf aus Stahlband.</i> | | 200 mm connector bar with 4 grub screws.
<i>200 mm Verbinder mit 4 Gewindestiften</i> |
| | 950 mm Vertical beam straight with 2 run of steel tape.
<i>950 mm Vertikalstrahl gerade mit 2 Lauf aus Stahlband.</i> | | 200 mm connector bar with 4 grub screws and a thread hole to accommodate adjustable foot.
<i>200 mm Verbinder mit 4 Gewindestiften und einem Gewindeloch für einen verstellbaren Fuß.</i> |
| | 750 mm Horizontal beam (curved) with 1 run of steel tape.
<i>750 mm Horizontalstrahl (gebogen) mit 1 Lauf aus Stahlband.</i> | | Expanding Clamp
<i>Klemme</i> |
| | 1000 mm Centro 8 way post.
<i>1000 mm Centro 8-fach Pfosten.</i> | | Spacer bar 110 mm. including 2 x expanding clamp
<i>Abstandhalter 110 mm. Einschließlich 2 x Klemme</i> |
| | Centro base.
<i>Centro Bodenplatte.</i> | | Spacer bar 220 mm. including 2 x expanding clamp
<i>Abstandhalter 220 mm. Einschließlich 2 x Klemme</i> |

Patented

www.centrodisplay.com

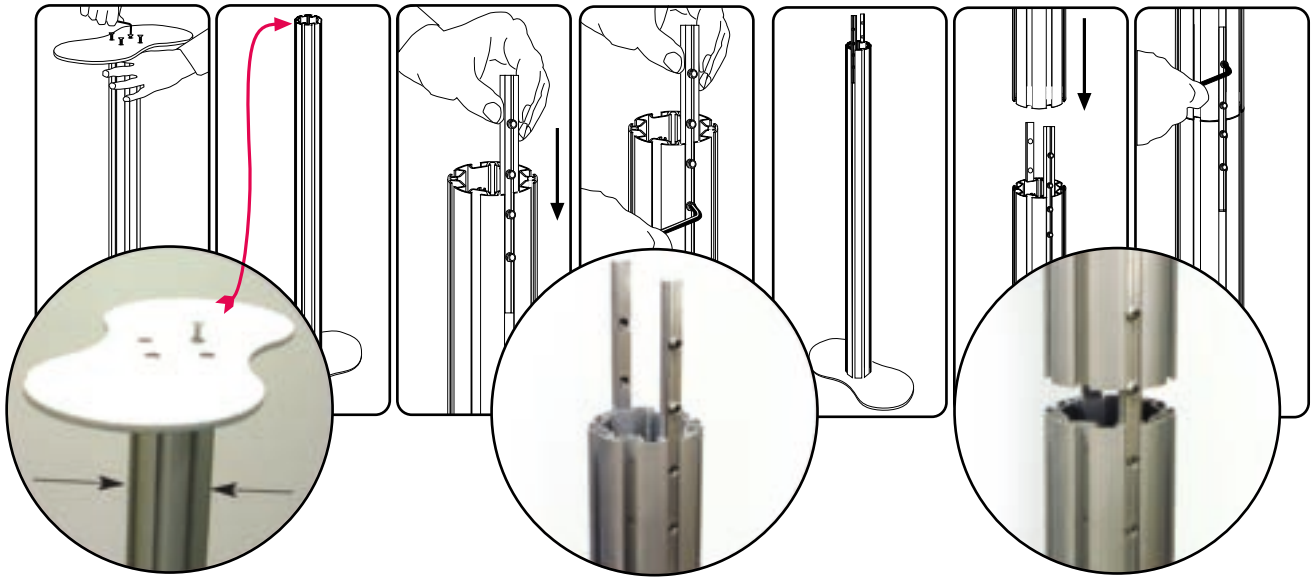

Attach base plate to lower column. Grooves containing connector bars should be at 90° to base plate.

Befestigen Sie die Bodenplatte an dem unteren Pfosten. Nuten, die Verbindungsstäbe enthalten, sollten bei 90° zur Bodenplatte gestellt sein.

Stand base on the ground. Loosen and slide connector bars half way out of groove and retighten.

Stellen Sie den Fuß auf dem Boden. Lösen und schieben Sie die Verbinder auf halbem Weg aus der Nut und ziehen Sie sie wieder fest.

Join posts and tighten the grub screws to make assembly secure. Repeat for other base post.

Verbinden Sie Pfosten und schließen Sie die Gewindestifte an, um Montage sicher zu machen. Wiederholen Sie für andere Untenpfosten.

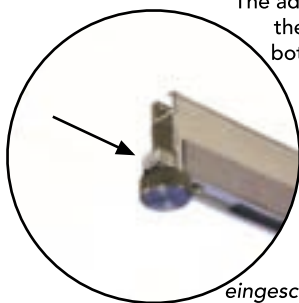

The adjustable feet should be screwed into the horizontal 750 mm rails used at the bottom of the system. Note position of tape. Connect the bottom horizontal rail to the two posts and tighten grub screws as before. Leave top rail until all verticals are in place. They will balance.

Die verstellbaren Füße sollten in die horizontalen Schienen 750 mm eingeschraubt werden, die an der Unterseite des Systems verwendet werden. Achten Sie auf die Position der Magnetbänder. Verbinden Sie die untere horizontale Schiene mit der beiden Pfosten und ziehen Sie die Gewindestifte wie zuvor fest. Lassen Sie die obere Schiene, bis alle Vertiefungen vorhanden sind. Sie werden ausgleichen.

The side and middle straight vertical 950 mm graphic rails should now be assembled. Note position of tape strips. Connect side vertical rails to the bottom horizontal rail. The side vertical rails have one run of tape on them. Tape should be nearest to the post when viewed from the front.

Die seitlichen und mittleren gerade vertikalen 950 mm-Profile sollten jetzt zusammengebaut werden. Achten Sie auf die Lage der Magnetstreifen. Verbinden Sie die seitlichen vertikalen Profile mit der unteren horizontalen Profile. Die seitlichen vertikalen Profile haben ein Laufband auf ihnen. Die Magnetstreifen sollte am vordersten zum Pfosten, wenn betrachtet von der Frontseite.

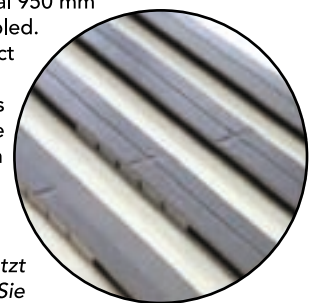

Stop top horizontal rail onto all vertical rails and tighten grub screws. Obere waagerechte Profile auf alle vertikalen Schienen stellen und Gewindestifte festziehen.

No Tool System Component & Accessories

Ohne Werkzeugsystem Komponente und Zubehör

Indoor - Innenbereich

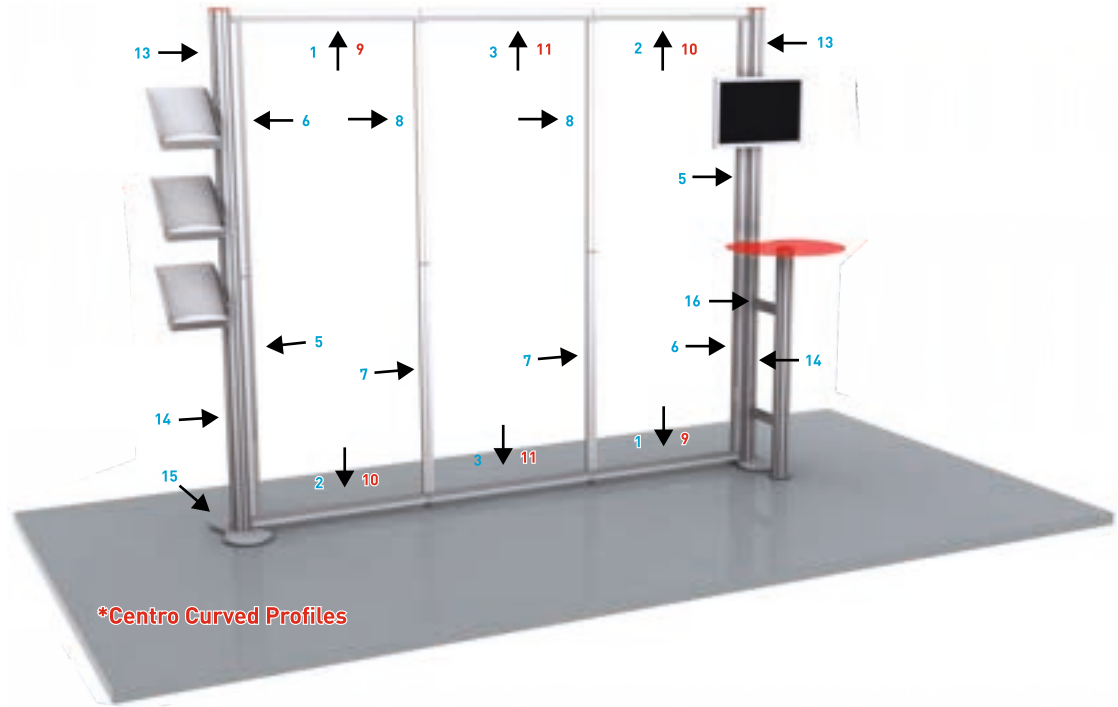

*Centro Curved Profiles



1 750 mm Horizontal beam straight with 1 run of steel tape and of male.
750 mm Horizontalstrahl gerade mit 1 Lauf Magnetband und Männlichverbinder.



2 750 mm Horizontal beam straight with 1 run of steel tape and of female.
750 mm Horizontalstrahl gerade mit 1 Lauf Magnetband und Weiblichverbinder.



3 750 mm Horizontal beam straight with 1 run of steel tape and of male & female.
750 mm Horizontalstrahl gerade mit 1 Lauf Magnetband und Männlich- und Weiblichverbinder.



4 750 mm Horizontal beam straight with 2 locks and 1 run of steel tape.
750 mm Horizontalstrahl gerade mit 2 T-Lock und 1 Lauf Magnetband.



5 950 mm Vertical beam straight with 1 run of steel tape and of male.
950 mm Vertikalstrahl gerade mit 1 Lauf Magnetband und Männlichverbinder.



6 950 mm Vertical beam straight with 1 run of steel tape and of female.
950 mm Vertikalstrahl gerade mit 1 Lauf Magnetband und Weiblichverbinder.



7 950 mm Vertical beam straight with 2 run of steel tape and of male.
950 mm Vertikalstrahl gerade mit 2 Lauf Magnetband und Männlichverbinder.



8 950 mm Vertical beam straight with 2 run of steel tape and of female.
950 mm Vertikalstrahl gerade mit 2 Lauf Magnetband und Weiblichverbinder.



9 750 mm Horizontal beam curve with 1 run of steel tape and of male.
750 mm Horizontalstrahl gebogen mit 1 Lauf Magnetband und Männlichverbinder.



10 750 mm Horizontal beam curve with 1 run of steel tape and of female.
750 mm Horizontalstrahl gebogen mit 1 Lauf Magnetband und 1 Weiblich-verbinder.



11 750 mm Horizontal beam curve with 1 run of steel tape and of male & female.
750 mm Horizontalstrahl gebogen mit 1 Lauf Magnetband und 1 Männlich- und Weiblichverbinder.



12 950 mm Horizontal beam curve with 2 locks and 1 run of steel tape.
950 mm Vertikalstrahl gebogen mit 2 T-Lock und 1 Lauf Magnetband.



13 1000 mm CENTRO T-Lock 8 Way post female, T-Lock + acrylic post cap.
1000 mm CENTRO T-Lock 8-fach Pfosten Weiblichverbinder und Acryl-Endkappe.

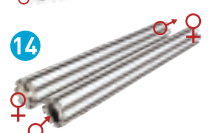

14 1000 mm CENTRO T-Lock 8 Way post female, T-Lock + Male T-Lock.
1000 mm CENTRO T-Lock 8-fach Pfosten Weiblich- und Männlichverbinder.



15 CENTRO T-Lock base.
CENTRO T-Lock Bodenplatte.



16 220 mm CENTRO Podium Desk connection profile.
220 mm CENTRO Podium Verbinder.

Patented

www.centrodisplay.com

CENTRO T-Lock Profiles for NO TOOL SYSTEM CENTRO T-Lock Profile für OHNE WERKZEUG SYSTEM

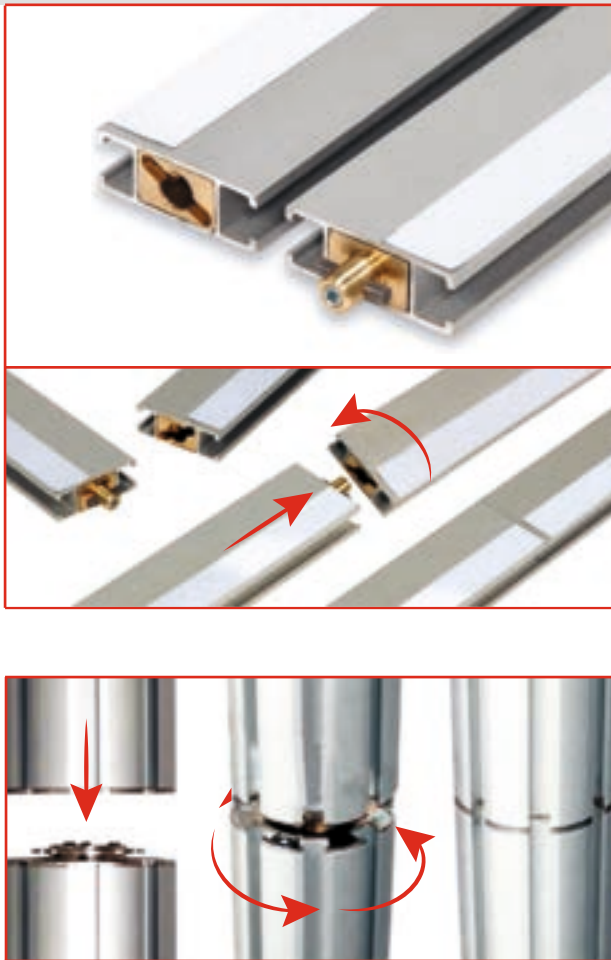

Indoor - Innenbereich

i  Fast and easy modular display solutions, twist and lock connection. The CENTRO portable modular display range been extremely successful as clients can assemble the robust systems themselves. Until now we have provided a NO TOOL locking system!..

The reason for this approach was to maintain strength and provide systems that will last. For the past few years we have been working to reduce the use of tools for assembly whilst maintaining the strength and durability of the connections.

The new CENTRO T-Lock (twist and lock) technology maintains the strength of the product whilst dramatically reducing assembly time by simply twisting and locking certain components together. The quality of materials used to manufacture the locks means any CENTRO modular system can be assembled and dismantled over and over again whilst maintaining its strength.

Our continued confidence in the build quality and long term reliability of these re-usable display systems is reflected in the 5 years guarantee we offer across the entire range.

DE Die langfristige Zuverlässigkeit dieser wiederverwendbaren Messesystem spiegelt sich in der 5-jährigen Garantie, die wir über das gesamte Sortiment bieten.

Schnelle und einfache modulare Messe-Display-Lösungen, Twist und Lock-Anschluss. Das CENTRO tragbare modulare Display-Programm war äußerst erfolgreich, da die Kunden die robusten Systeme selbst anpassen können. Von nun an haben wir eine Schließanlage NO TOOL – OHNE WERKZEUG!

Der Grund für diesen Ansatz war, die Strecke zu halten und Systeme, die dauern wird. In den letzten Jahren haben wir gearbeitet, um die Verwendung von Werkzeugen für die Montage zu reduzieren, während die Festigkeit und die Haltbarkeit der Verbindungen beibehalten werden.

Die neue CENTRO T-Lock -Technologie hält die Festigkeit des Produkts aufrecht und reduziert gleichzeitig die Montagezeit durch einfaches Verdrehen und Verriegeln bestimmter Komponenten. Die Qualität der für die Herstellung der Schlösser verwendeten Materialien bedeutet, dass jedes CENTRO-Modularsystem unter Beibehaltung seiner Stärke immer wieder montiert und demontiert werden kann.

Unser anhaltendes Vertrauen in die Bauweise und die langfristige Zuverlässigkeit dieser wiederverwendbaren Messe-Display-Systeme spiegelt sich in der 5-jährigen Garantie, die wir im gesamten Sortiment bieten.

CENTRO Easy Lock Frame Profiles for NO TOOL SYSTEM

CENTRO Einfach Verschluss Rahmenprofile für OHNE WERKZEUG SYSTEM

 Easy no tool assembly, Say goodbye to all tools!

- The easier system for self-build.
- Build your stand without the need for levelling!...
- Extremely portable.

Time saver aluminium frameworks can now be assembled quickly and easily, without tools. Centro press & lock clamp is a lever operated clamp that creates a strong secure connection of aluminium beams and posts.

Self-build exhibitors can now build a framework quickly and easily – without the fuss of using tools. Centro press & lock clamp is even strong enough to attach base supports to vertical posts, speeding up assembly time and reducing costs.

If you want a custom built exhibition stand but need it to be strong, re-usable and re-shapeable for multiple events, Centro system is your perfect choice. Fast, no tool assembly and a wide range of graphic and accessory options means Centro System gives you the best visual impact for your investment.

Offers maximum impact and a contemporary look with the height up to four meters with a wide range of graphics options including foamboard, textiles and even hard panel. Centro can even be designed as one system to fit multiple stand sizes.

 Einfache Montage, Abschied von allen Werkzeugen!

- Das einfachere System für Selbstbau.
- Bauen Sie Ihren Stand ohne die Notwendigkeit der Werkzeuge.
- Extrem tragbar.

Zeitsparende Aluminiumbau können nun schnell und einfach, ohne Werkzeuge montiert werden. Die Centro Press & Lock Klemme ist eine Hebelklemme, die eine sichere Verbindung von Aluminiumstrahlen und Pfosten herstellt.

Selbstgestaltete Aussteller können nun schnell und unkompliziert einen Messestand bauen - ohne Einsatz von Werkzeugen. Centro Press & Lock Klemme ist sogar stark genug, um Bodenplatte an vertikalen Pfosten zu befestigen, Beschleunigung Montagezeit und Senkung der Kosten.

Wenn Sie eine benutzerdefinierte Messestand, die auch stark und stabil sein muss, wiederverwendbar und umformbar für mehrere Veranstaltungen, Centro-System ist Ihre perfekte Wahl. Fast, keine Werkzeugmontage und eine breite Palette von Grafik- und Zubehör-Optionen bedeutet, dass Centro System Ihnen die beste visuelle Wirkung für Ihre Investition bietet.

Bietet maximale Wirkung und einen zeitgenössischen Schau mit der Höhe bis zu vier Metern mit einer breiten Palette von Grafik-Optionen wie Schaumstoff, Textilien und sogar Hartplatte. Centro kann sogar als ein System konzipiert werden, um mehrfache Standgrößen zu passen.

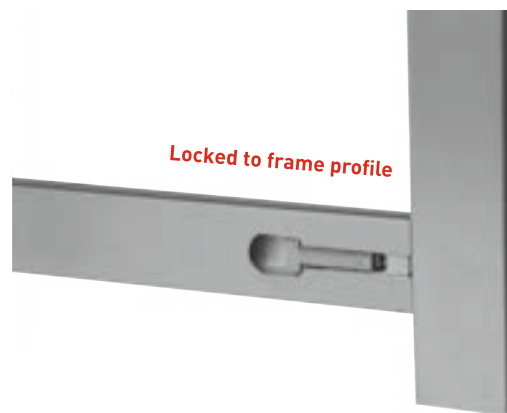
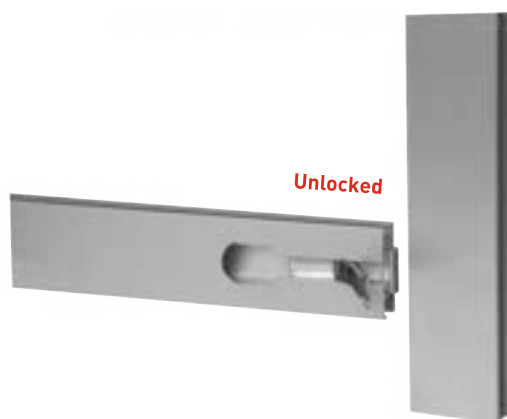

Patented

www.centrodisplay.com

CENTRO Shell Scheme Designs | *CENTRO Shell Scheme Designs*

Indoor - Innenbereich

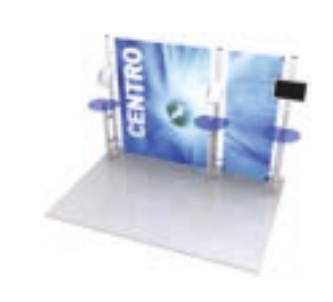

CENTRO Window I *CENTRO Window*

Indoor - Innenbereich

- 🇬🇧 * Designed for simple magnetic fixing of your graphic panel.
- * Innovative modular display system.
- * Contemporary neon acrylic features.
- * Unique, robust anodised aluminium construction
- * Requiring only a single hex bit or "No Tool System" for complete assembly.
- * Tool kit supplied.
- * Shaped silver base plate to maximize stability.
- * Overall height without lighting 2014 mm.
- * 5 years guarantee.

- 🇩🇪 * Entworfen für einfache magnetische Befestigung Ihrer Grafikpaneele
- * Innovatives modulares Messe-Display-System.
- * Zeitgenössische Neon-Acryl-Zubehör.
- * Einzigartige, robuste eloxierte Aluminiumkonstruktion
- * Für die komplette Montage nur ein einziges Inbusschlüssel oder "No Tool System" erforderlich.
- * Mitgelieferte Werkzeug.
- * 8 geformte silberne Bodenplatte, die Stabilität zu maximieren.
- * Gesamthöhe ohne Beleuchtung 2014 mm.
- * 5 Jahre Garantie.



Patented

www.centrodisplay.com

CENTRO Window | CENTRO Window

Indoor - Innenbereich

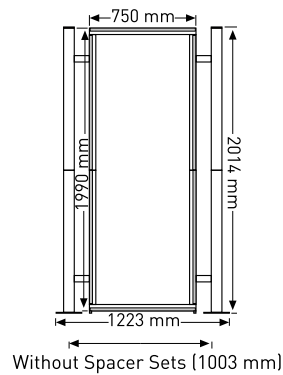

C1 & CS1 750 mm x 1990 mm

- 2 x Centro Base
- 8 x Centro Base Screw
- 4 x 1000 mm Centro 8 Way Post
- 2 x Post Cap with 2 Screws
- 2 x 750 mm Horizontal Beam - Straight with 1 Run of Steel Tape
- 4 x 950 mm Vertical Beam - Straight with 1 Run of Steel Tape
- 8 x Connector Bar with 4 grub screws - 200 mm
- 4 x Expanding Clamp
- 4 x Spacer Sets Incl. 2 Expanding Clamps
- 5 x Baseplate Adjustment Screw

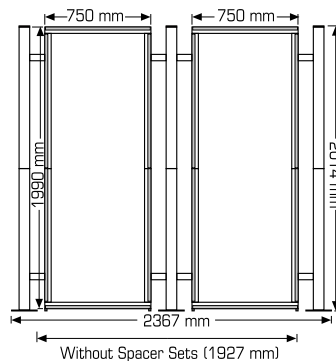

C2 & CS2 750 mm x 1990 mm

- 3 x Centro Base
- 12 x Centro Base Screw
- 6 x 1000 mm Centro 8 Way Post
- 3 x Post Cap with 2 Screws
- 4 x 750 mm Horizontal Beam - Straight with 1 Run of Steel Tape
- 8 x 950 mm Vertical Beam - Straight with 1 Run of Steel Tape
- 14 x Connector Bar with 4 grub screws - 200 mm
- 16 x Expanding Clamp
- 8 x Spacer Sets Incl. 2 Expanding Clamps
- 4 x Baseplate Adjustment Screw

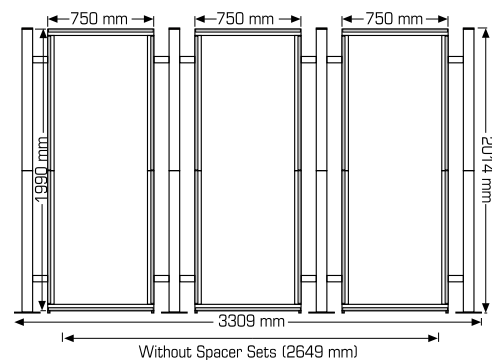

C3 & CS3 (3x750 mm) x 1990 mm

- 4 x Centro Base
- 16 x Centro Base Screw
- 8 x 1000 mm Centro 8 Way Post
- 4 x Post Cap with 2 Screws
- 6 x 750 mm Horizontal Beam - Straight with 1 Run of Steel Tape
- 12 x 950 mm Vertical Beam - Straight with 1 Run of Steel Tape
- 20 x Connector Bar with 4 grub screws - 200 mm
- 12 x Expanding Clamp
- 12 x Spacer Sets Incl. 2 Expanding Clamps
- 6 x Baseplate Adjustment Screw

CENTRO Straight I *CENTRO Straight*

UK **Versatile:** You can either choose one of our preconfigured structures or create endless configurations to suit your needs. With its extension bars and locking mechanism it is up to you decide the height, the width and space of the units.

Portable: A user friendly system. Very easy to install the system according to the assembly sheet using a single hex key presupplied in its bag. Easily transported in its own set of carry bags.

Sturdy: Stability is achieved by 75 mm diameter aluminium posts and 6 mm thick galvanized steel base plates.

Elegant: 8-way round posts, stylish base plates, neon acrylic end-caps and innovative accessory range. Elegancy and mobility combined in the same system.

DE **Vielseitig:** Sie können entweder eine unserer vorkonfigurierten Strukturen wählen, um endlose Konfigurationen für Ihre Anforderungen zu erstellen. Mit den Verlängerungsstangen und dem Verriegelungsmechanismus können Sie die Höhe, die Breite und die Form der Einheiten bestimmen.

Portable: Ein benutzerfreundliches System. Sehr einfach zu installieren das System nach dem Montageblatt mit einem einzigen Sechskantschlüssel mitgeliefert in der Tragetasche. Leicht transportiert in einer eigenen Tragetasche

Robust: Stabilität wird erreicht durch 75 mm Durchmesser Aluminiumpfosten und 6 mm dicke verzinkte und beschichtete Stahlbodenplatten.

Elegant: 8-fach runde Pfosten, stilvolle Basisplatten, Neon-Acryl-Endkappen und innovatives Zubehörprogramm. Eleganz und Mobilität kombiniert in demselben System.



Patented



www.centrodisplay.com

CENTRO Straight | CENTRO Straight

Indoor - Innenbereich

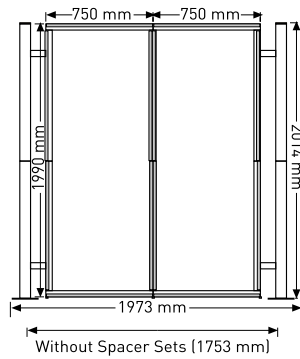

CG2 & CGS2 1500 mm x 1990 mm

- 2 x Centro Base
- 8 x Centro Base Screw
- 4 x 1000 mm Centro 8 Way Post
- 2 x Post Cap with 2 Screws
- 4 x 750 mm Horizontal Beam - Straight with 1 Run of Steel Tape
- 4 x 950 mm Vertical Beam - Straight with 1 Run of Steel Tape
- 2 x 950 mm Beam - Straight with Run of Steel Tape
- 11 x Connector Bar with 4 grub screws - 200 mm
- 1 x Connector Bar with 4 grub screws and a threaded hole to accommodate adjustable foot - 200 mm

- 4 x Expanding Clamp
- 4 x Spacer Sets Incl. 2 Expanding Clamps
- 5 x Baseplate Adjustment Screw

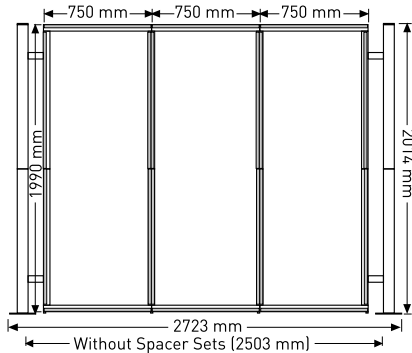

CG3 & CGS3 2250 mm x 1990 mm

- 2 x Centro Base
- 8 x Centro Base Screw
- 4 x 1000 mm Centro 8 Way Post
- 2 x Post Cap with 2 Screws
- 6 x 750 mm Horizontal Beam - Straight with 1 Run of Steel Tape
- 4 x 950 mm Vertical Beam - Straight with 1 Run of Steel Tape
- 4 x 950 mm Beam - Straight with Run of Steel Tape
- 14 x Connector Bar with 4 grub screws - 200 mm
- 2 x Connector Bar with 4 grub screws and a threaded hole to accommodate adjustable foot - 200 mm

- 8 x Expanding Clamp
- 4 x Spacer Sets Incl. 2 Expanding Clamps
- 4 x Baseplate Adjustment Screw

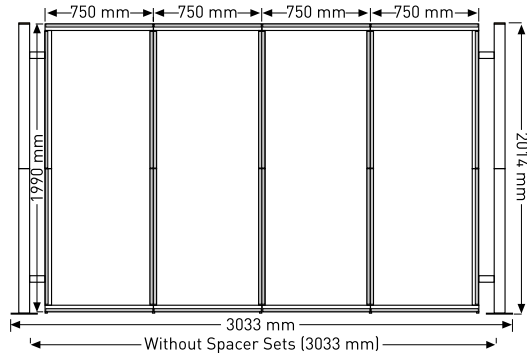

CG4 & CGS4 3000 mm x 1990 mm

- 2 x Centro Base
- 8 x Centro Base Screw
- 4 x 1000 mm Centro 8 Way Post
- 2 x Post Cap with 2 Screws
- 8 x 750 mm Horizontal Beam - Straight with 1 Run of Steel Tape
- 4 x 950 mm Vertical Beam - Straight with 1 Run of Steel Tape
- 6 x 950 mm Beam - Straight with Run of Steel Tape
- 17 x Connector Bar with 4 grub screws - 200 mm
- 3 x Connector Bar with 4 grub screws and a threaded hole to accommodate adjustable foot - 200 mm

- 10 x Expanding Clamp
- 4 x Spacer Sets Incl. 2 Expanding Clamps
- 5 x Baseplate Adjustment Screw

CENTRO Curved I CENTRO Curved

- ✚ * Designed for a visually-seamless magnetic graphic panel.
- * Innovative modular display system.
- * Contemporary neon acrylic features.
- * Unique, robust anodised aluminium construction
- * Requiring only a single hex bit for complete assembly or "No Tool System".
- * Shaped silver base plate to maximize stability.
- * Overall height without lighting 2014 mm.
- * Quality assured 5 years guarantee.
- * Extra perspective by curved rails.

- 🇩🇪 * Entworfen für eine optisch-nahtlose magnetische Grafikpaneel.
- * Innovatives modulares Messe-Display-System.
- * Zeitgenössische Neon-Acryl-Zubehör.
- * Einzigartige, robuste eloxierte Aluminiumkonstruktion
- * Benötigt nur einen einzigen Inbusschlüssel für Komplettmontage oder "Ohne Werkzeug System".
- * 8 geformte silberne Bodenplatte, die Stabilität zu maximieren.
- * Gesamthöhe ohne Beleuchtung 2014 mm.
- * 5 Jahre Garantie.
- * Extraperspektive durch gebogene Schienen.



Patented



www.centrodisplay.com

CENTRO Curved | CENTRO Curved

Indoor - Innenbereich

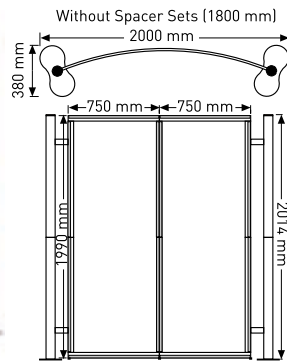

CG2C & CGS2C 1500 mm x 1990 mm

- 2 x Centro Base
- 8 x Centro Base Screw
- 4 x 1000 mm Centro 8 Way Post
- 2 x Neon Post Caps Incl. Screws
- 4 x 750 mm Horizontal Curved Beam with 1 Run of Steel Tape
- 4 x 950 mm Vertical Beam - Straight with 1 Run of Steel Tape
- 2 x 950 mm Beam - Straight with 2 Run of Steel Tape
- 11 x Connector Bar with 4 grub screws - 200 mm
- 1 x Connector Bar with 3 grub screws - 100 mm
- 3 x Connector Bar with 4 grub screws and a threaded hole to accommodate adjustable foot - 200 mm

- 6 x Expanding Clamp
- 4 x Spacer Sets Incl. 2 Expanding Clamps
- 3 x Adjustable Foot for Uneven Floor

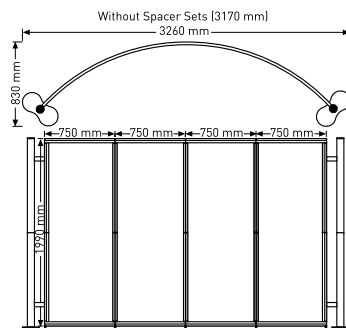
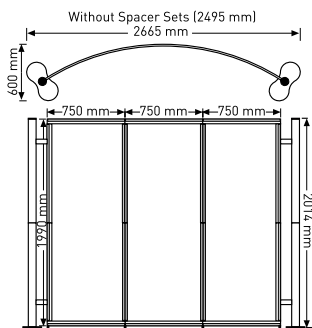

CG3C & CGS3C 2250 mm x 1990 mm

- 2 x Centro Base
- 8 x Centro Base Screw
- 4 x 1000 mm Centro 8 Way Post
- 2 x Neon Post Caps Incl. Screws
- 6 x 750 mm Horizontal Curved Beam with 1 Run of Steel Tape
- 4 x 950 mm Vertical Beam - Straight with 1 Run of Steel Tape
- 4 x 950 mm Beam - Straight with 2 Run of Steel Tape
- 12 x Connector Bar with 4 grub screws - 200 mm
- 2 x Connector Bar with 3 grub screws - 100 mm
- 4 x Connector Bar with 4 grub screws and a threaded hole to accommodate adjustable foot - 200 mm

- 8 x Expanding Clamp
- 4 x Spacer Bar with 1 off Expanding Clamps
- 4 x Adjustable Foot for Uneven Floor

CG4C & CGS4C 3000 mm x 1990 mm

- 2 x Centro Base
- 8 x Centro Base Screw
- 4 x 1000 mm Centro 8 Way Post
- 2 x Neon Post Caps Incl. Screws
- 8 x 750 mm Horizontal Curved Beam with 1 Run of Steel Tape
- 4 x 950 mm Vertical Beam - Straight with 1 Run of Steel Tape
- 6 x 950 mm Beam - Straight with 2 Run of Steel Tape
- 14 x Connector Bar with 4 grub screws - 200 mm
- 3 x Connector Bar with 3 grub screws - 100 mm
- 5 x Connector Bar with 4 grub screws and a threaded hole to accommodate adjustable foot - 200 mm

- 10 x Expanding Clamp
- 4 x Spacer Sets Incl. 2 Expanding Clamps
- 5 x Adjustable Foot for Uneven Floor

CENTRO Banner | CENTRO Banner

Indoor - Innenbereich

- 🇬🇧 **Versatile:** You can either choose one of our preconfigured structures or create endless configurations to suit your needs. With its extension bars and locking mechanism it is up to you to decide the height, the width and space of the units.
- Portable:** A user friendly system. Very easy to install the system according to the assembly sheet using a single hex key presupplied in its bag. Easily transported in its own set of carry bags.
- Sturdy:** Stability is achieved by 75 mm diameter aluminium posts and 6 mm thick galvanized steel base plates.
- Elegant:** 8-way round posts, stylish base plates, neon acrylic end-caps and innovative accessory range. Elegancy and mobility combined in the same system

- * Designed for a single banner graphic with horizontally hemmed pockets.
- * Innovative modular display system.
- * Contemporary neon acrylic features.
- * Unique, robust anodised aluminium construction
- * Requiring only a single hex bit for complete assembly.
- * 4 mm. Hex key supplied.
- * Shaped silver base plate to maximize stability.
- * Quality assured 5 years guarantee.

- 🇩🇪 **Vielseitig:** Sie können entweder eine unserer vorkonfigurierten Strukturen wählen, um endlose Konfigurationen für Ihre Anforderungen zu erstellen. Mit den Verlängerungsstangen und dem Verriegelungsmechanismus können Sie die Höhe, die Breite und die Form der Einheiten bestimmen.
- Portable:** Ein benutzerfreundliches System. Sehr einfach zu installieren das System nach dem Montageblatt mit einem einzigen Sechskantschlüssel mitgeliefert in der Tragetasche. Leicht transportiert in einer eigenen Tragetasche.
- Robust:** Stabilität wird erreicht durch 75 mm Durchmesser Aluminiumpfosten und 6 mm dicke verzinkte und beschichtete Stahlbodenplatten.
- Elegant:** 8-fach runde Pfosten, stilvolle Basisplatten, Neon-Acryl-Endkappen und innovatives Zubehörprogramm. Eleganz und Mobilität kombiniert in demselben System.

- * Entworfen für eine einzelne Textilgrafik mit horizontal gesäumten Taschen
- * Innovatives modulares Messe-Display-System.
- * Zeitgenössische Neon-Acryl-Zubehör.
- * Einzigartige, robuste eloxierte Aluminiumkonstruktion
- * Benötigt nur einen einzigen Inbusschlüssel für Komplettmontage.
- * 4mm Inbusschlüssel mitgeliefert
- * 8 geformte silberne Bodenplatte, die Stabilität zu maximieren.
- * 5 Jahre Garantie.



Patented

www.centrodisplay.com

CENTRO Rigid Panel | CENTRO Hartpaneele

Using our modern and flexible modular systems, you may create a modular structure specifically for your company needs.

This gives you an advantage of competitively priced re-useable systems. CENTRO exhibition systems used in modular exhibition booths can be finished in any colour you wish

Features

- * Lightweight Portable & Sturdy Aluminium Frame.
- * Easy set-up and dismantle.
- * Sustainable use (cost-saving for long term usage).
- * Free design service for your need.
- * Fully portable.
- * Easily transported.
- * Possibility of expanding.
- * Re-useable.
- * Reconstructed accommodating to place, time and any other requirements.

You can realize almost any imaginable structure with all the benefits of bespoke system. CENTRO Exhibition Systems can be used build systems stands, display units. In this system, you can use rigid panels, for example foam PVC, acrylic, MDF, glass panels. There are no limits to the adaptability of the CENTRO system neither from a creative or from a technical point of view.

You can achieve an outstanding modern and contemporary exhibition booth.

Mit unseren modernen und flexiblen modularen Systemen können Sie eine modulare Struktur für Ihre Unternehmensanforderungen erstellen.

Dies gibt Ihnen einen Vorteil von wettbewerbsfähigen wiederverwendbaren Systemen. CENTRO Ausstellungssysteme, die in modularen Messeständen verwendet werden, können in jeder gewünschten Farbe fertig gestellt werden.

Eigenschaften

- * Leichte tragbare und robuste Aluminium-Konstruktion.
- * Einfache Aufstellung und Demontage.
- * Nachhaltige Nutzung (Kosten sparend für langfristige Nutzung).
- * Kostenlose Design-Service für Ihre Bedürfnisse.
- * Vollständig portable.
- * Einfach transportiert.
- * Möglichkeit der Erweiterung.
- * Wiederverwendbar.
- * Rekonstruktion anpassend zum Ort, zur Zeit und zur anderen Anforderungen.

Sie können fast jede erdenkliche Struktur mit allen Vorteilen der maßgeschneiderten System zu realisieren. CENTRO Messe Systeme können als Großartige Messestände oder Display-Anzeige verwendet werden. In diesem System können Sie Hartplatten, wie zB Schaumstoff PVC, Acryl, MDF, Glas verwenden. Die Anpassungsfähigkeit des CENTRO-Systems ist weder kreativ noch technisch unbegrenzt.

Sie erreichen einen modernen und zeitgenössischen Messestand.



CENTRO Totem I *CENTRO Totem*

 The classy design of the totem is an eye catcher by itself. It integrates perfectly into the environment and is ideally suited as a welcome / advertising / announcement display.

- * Designed for simple magnetic fixing of your graphic panel.
- * 500 mm. wide x 1990 mm. high graphic area.
- * 3 x A4 portrait brochure holders, steel or neon acrylic.
- * Unique, robust anodised aluminium construction.
- * Requiring only a single hex key supplied for complete assembly.
- * Shaped silver base plate to maximise stability.
- * Quality assured 5 years guarantee.
- * Total height 2014 mm.

 *Klasse Design des Totems ist selbst ein Blickfang. Es integriert sich perfekt in die Umgebung und eignet sich ideal als Begrüßungs- / Werbe- / Ansage-Display.*

- * *Entworfen für eine optisch-nahtlose magnetische Grafikpaneel.*
- * *500 mm. Breite x 1990 mm. Hohe Grafikfläche.*
- * *3 x A4 Hochformat-Prospektständer, Stahl oder Neon-Acryl.*
- * *Einzigartige, robuste eloxierte Aluminiumkonstruktion.*
- * *Benötigt nur einen einzigen Inbusschlüssel für Komplettmontage*
- * *8 geformte silberne Bodenplatte, die Stabilität zu maximieren.*
- * *Gesamthöhe ohne Beleuchtung 2014 mm.*
- * *5 Jahre Garantie.*

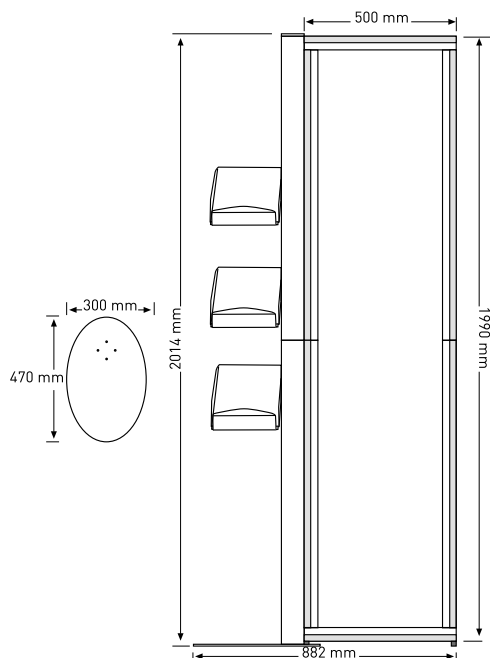

Patented

www.centrodisplay.com

CENTRO Barrier | CENTRO Barrier

Indoor - Innenbereich
Outdoor - Außenbereich

 As the specialists in cafe barriers and accessories, we offer CENTRO Barrier Systems to cater for every environment and budget.

The CENTRO cafe barrier system is a high-end product perfect for restaurants, hotels and outdoor areas and its silver finish and solid bases ensure a long-lasting product. Practical and perfect for almost any location, the CENTRO cafe barrier system is strong, hard-wearing and great value for money.

CENTRO Barriers in five sizes: 0,75 m. - 0,95 m. - 1,5 m. - 1,9 m. - 2,25m.

 Als Spezialisten für Café-Barrieren und Zubehör bieten wir CENTRO Barrier Systems für jede Umgebung und jedes Budget.

Das CENTRO-Kaffeebarrieresystem ist ein Klasse-Produkt und perfekt für Restaurants, Hotels und Außenbereiche. Silberfarbe beschichtete und stabile Bodenplatten sorgen für ein langlebiger Produkt. Praktisch und perfekt für fast jedes Standort, ist das CENTRO Café Barrier-System stark und ein gutes Preis-Leistungs-Verhältnis.

CENTRO Barriers in fünf Größen: 0,75 m. - 0,95 m. - 1,5 m. - 1,9 m. - 2,25 m.

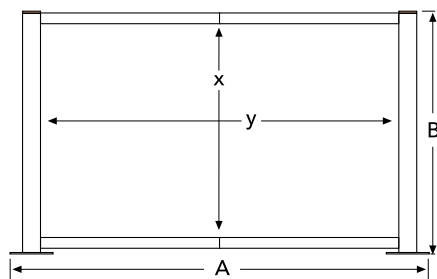

EXTRUSION: SILVER COLOR (ANODIZED) ALUMINIUM			
ITEM CODE	PANEL SIZES	VISIBLE AREA (Y/X)	EXTERNAL SIZE(A/B)
CBR1 075100	765 x 935 mm	734 x 920 mm	1004 x 1014 mm
CBR1 095100	965 x 935 mm	934 x 920 mm	1204 x 1014 mm
CBR2 150100	1515 x 935 mm	1484 x 920 mm	1754 x 1014 mm
CBR2 190100	1915 x 935 mm	1884 x 920 mm	2154 x 1014 mm
CBR3 225100	2265 x 935 mm	2234 x 920 mm	2504 x 1014 mm

CENTRO Showcase | CENTRO Vitrinen

Indoor - Innenbereich

- * A knockdown trade show display or a permanent retail fixture
- * Elegant high-quality anodised aluminium modular showcase
- * Header and graphics area available to print your company logo or promotional images
- * 3 mm thick tempered glass shelves each size 316 mm depth and 595 mm width
- * Total height 2050 mm
- * You can assemble glass shelves and other components between two ready CENTRO stand side poles!..

- * Ein zerlegbares Messe-Display oder ein permanenter Retail-Stand
- * Eleganter, hochwertiger, silbern eloxierter, modularer Schaukästen
- * Topschild und Grafik-Fläche zur Verfügung, um Ihr Firmenlogo oder Werbebilder zu drucken
- * 6 mm Dicke gehärtete Glasböden jeder Größe 316 mm Tiefe und 595 mm Breite
- * Gesamthöhe 2050 mm
- * Sie können Glasböden und andere Komponenten zwischen zwei vorgefertigten CENTRO Ständer montieren!..

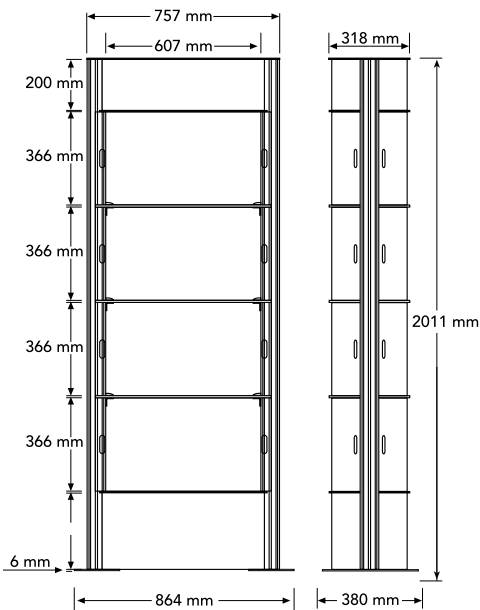

EXTRUSION: SILVER COLOR (ANODIZED) ALUMINIUM

ITEM CODE	SHELF SIZES	TOP LOGO AREA	BOTTOM LOGO AREA
CDOLAP	595 x 316 mm	710 x 200 mm	710 x 300 mm

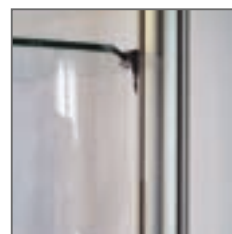

Patented

www.centrodisplay.com

CENTRO Console | CENTRO Konsole



- * A knockdown trade show display or a permanent retail fixture
- * Elegant high-quality anodised aluminium modular console
- * Header and graphics area available to print your company logo or promotional images
- * 4 tempered glass shelves each size 316 mm depth and 595 mm width
- * Total height 2014 mm
- * You can assemble glass shelves and other components between two ready CENTRO stand side poles!..

- * Ein zerlegbares Messe-Display oder ein permanenter Retail-Stand
- * Elegante, hochwertige, silbern eloxierte, modulare Konsole
- * Topschild und Grafik-Fläche zur Verfügung, um Ihr Firmenlogo oder Werbebilder zu drucken
- * 6 mm. Dicke gehärtete Glasböden jeder Größe 316 mm Tiefe und 595 mm Breite
- * Gesamthöhe 2014 mm
- * Sie können Glasböden und andere Komponenten zwischen zwei vorgefertigten CENTRO Ständer montieren!..

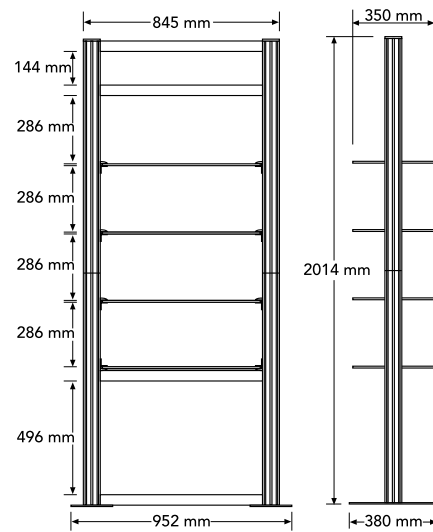

Indoor - Innenbereich



EXTRUSION: SILVER COLOR (ANODIZED) ALUMINIUM

ITEM CODE	SHELF SIZES	TOP LOGO AREA	BOTTOM LOGO AREA
CRAF	670 x 330 mm	700 x 144 mm	700 x 496 mm



CENTRO Slatwall I *CENTRO Slatwall*

- 🇬🇧 * Designed for use in the retail environment or at an exhibition
- * Unlike traditional slatwall panels our grooves are completely constructed from E6-EV1 quality aluminium meaning no cracks or fractures when displaying heavier items
- * 7 grooves far add on pockets. You can increase additional panels up on your request
- * You can apply any color of MDF (medium density fiberboard) panels
- * And you can laminate printed material to surface of MDF panels
- * Main hard body constructed from 8 mm thick melamine faced hardboard, standing profiles in silver finish aluminium
- * This unit is able to display a wide variety of products
- * Single side
- * You can assemble slatwall panels between two ready CENTRO stand side poles!..

- 🇩🇪 * Entworfen für Gebrauch im Einzelhandel oder auf einer Ausstellung
- * Im Gegensatz zu herkömmlichen Lamellenpaneelen sind unsere Rillen komplett aus E6-EV1 Aluminium gefertigt und erfolgen keine Risse oder Brüche bei der Darstellung schwerer Gegenstände
- * 7 Rillen für aufgesetzte Taschen und HalterSie können zusätzliche Rillen auf Ihre Anfrage erhalten
- * Sie können jede mögliche Farbe von MDF - Platten anwenden
- * Sie können gedrucktes Material auf Oberfläche der MDF-Platten laminieren
- * Hauptkonstruktion aus 8 mm starke melaminbeschichtete Hartfaserplatte, Standprofile aus silbern eloxierten Aluminium
- * Dieser Ständer ist in der Lage, eine breite Vielzahl der Produkte anzuzeigen
- * Ein- oder doppelseitig
- * Sie können Slatwall Paneele zwischen zwei vorgefertigten CENTRO Ständer montieren!..

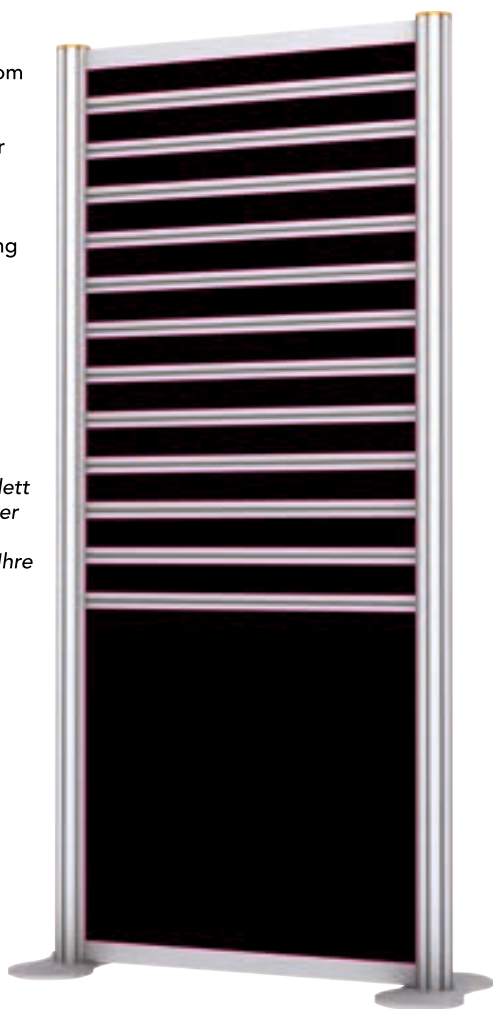

EXTRUSION: SILVER COLOR (ANODIZED) ALUMINIUM

MELAMINE FACED HARDBOARD PANELS

ITEM CODE	GROVES	EXTERNAL SIZE
CSS 075200-12	12	896 x 2000 mm

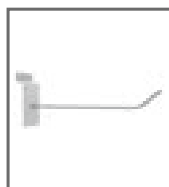
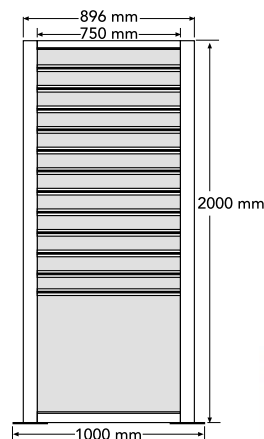
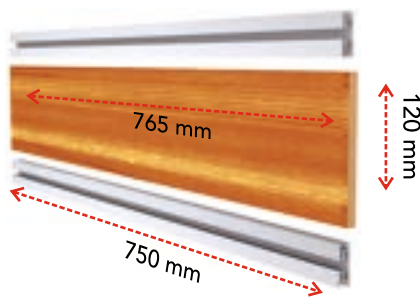

STEEL HOOK
MATERIAL: GALVANISED STEEL

ITEM CODE	HOOK SIZES
ASW 100	100 mm
ASW 150	150 mm
ASW 200	200 mm



POSTER HOLDER
MATERIAL: CLEAR ACRYLIC

ITEM CODE	SHELF SIZES
PSW 030042	300 x 420 mm
PSW 050070	500 x 700 mm
PSW 060084	594 x 941 mm



BROCHURE HOLDERS
MATERIAL: CLEAR ACRYLIC

ITEM CODE	SHELF SIZES
BHSW 1121	120 x 220 mm
BHSW 1521	150 x 220 mm
BHSW 2130	220 x 310 mm



MERCHANDISE SHELF
MATERIAL: CLEAR ACRYLIC

ITEM CODE	SHELF SIZES
RSW 015025	150 x 200 mm
RSW 020030	200 x 300 mm
RSW 030030	300 x 300 mm

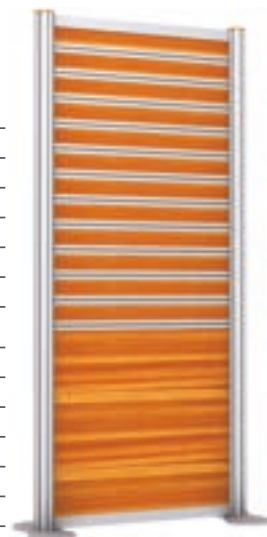

Patented

Special designs & sizes applicable upon your request.

www.centrodisplay.com

CENTRO Store Room Doors | CENTRO Abstellraum-Tür

- 🇬🇧 * If you need a secured storage facility with a door at one end of your stand, we have !..
- * You can build up your storage from 0,56 m² up to 4,5 m²
- * Store Room Doors can be assembled between two ready CENTRO poles without side poles !..

- 🇩🇪 * Wenn Sie ein gesicherter Lager mit einer Tür in Ihrem Messe-Stand benötigen, haben wir es!..
- * Sie können Ihre Lagerung von 0,56 m² bis zu 4,5 m² aufbauen
- * Abstellraum Türen können zwischen zwei vorgefertigten CENTRO Ständer montieren!..



Indoor - Innenbereich



MATERIAL: ALUMINIUM AND FOAM PVC

ITEM CODE	DOOR SIZES
CKP 075200	765 x 935 mm
CKP 095200	965 x 935 mm

CENTRO Podium Desk | CENTRO Podium Desk

-  * Ergonomically-designed neon acrylic
- * Available blue, green, red or standart frost
- * Contemporary design to enhance visual impact of modular display system

-  * *Ergonomisches Neon-Acryl Design*
- * *Verfügbar blau, grün, rot oder standart Frost*
- * *Zeitgenössisches Design zur Erhöhung der visuellen Auswirkungen von modularen Display-System*





Colours of
NEON ACRYLIC
Farben von Neon-Acryl



CENTRO Neon Acrylic Brochure Holder

CENTRO Neon Acryl Prospekthalter

-   * Available in blue, green, red, pink or red or standart frost
- * Thermoformed one piece acrylic to maximise strength
- * Simple hook over style fitting

-  * *Vorhanden im blauen, grünen, roten oder standart Frost*
- * *Thermogeformtes einteiliges Acryl, zum von Auftrigungs-Stärke zu maximieren*
- * *Einfache Hakensystem*



CENTRO Desk

CENTRO Desk



Patented

* See page 156
for Centro Desk

* *Siehen Sie bitte Seite 156
für Centro Desk*

CENTRO Counter

CENTRO Counter



* See page 157
for Centro Counter

* *Siehen Sie bitte Seite 157
für Centro Counter*

www.centrodisplay.com



LCD Connector

- * Simple design and uncomplicated assembly with tool supplied
- * Screen size up to 22" can be fitted to the bracketed

LCD-Halter

- * Einfache Konstruktion und unkomplizierte Montage mit mitgeliefertem Werkzeug
- * Display-Größe bis 22" kann an der Halterung angebracht werden



Laptop Shelf

- * Lightweight robust shelf finished in silver
- * Supplied with expanding bracket and fixing tool
- * 400 mm x 280 mm

Laptop Ablage

- * Leichtes robustes Regal in Silber Farbe
- * Lieferung mit dem Befestigungswerkzeug
- * 400 mm x 280 mm Fläche



Brochure Holder - Steel

- * Powder coated steel A4 portrait brochure holder
- * Available in grey finish, perfect match with aluminium
- * Fitted to the CENTRO System post with connector bars (included in box)

Prospekthalter - aus Stahl

- * Pulverbeschichteter Stahl A4 Hochformat-Prospekthalter
- * Erhältlich in grauer Farbe, perfekte Übereinstimmung mit Aluminium
- * Passend zum CENTRO Systempfosten mit Verbinder (im Lieferumfang enthalten)



Spot Light

- * 10 watt LED lamp
- * Flexible head design
- * Plastic peg style fastener
- * European plug & on of switch

Spot Licht

- * 10 Watt LED-Lampe
- * Flexibles Kopfdesign
- * Kunststoff-Klettverschluss
- * Europäisches plug & on off Schalter



iPad Connector

- * Simple design
- * Assembly with tool supplied

iPad Halter

- * Einfaches Design
- * Montage mit mitgeliefertem Werkzeug

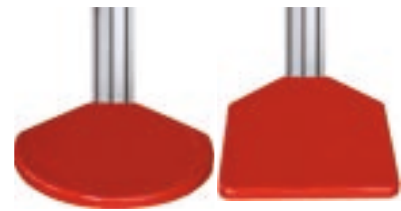

Display Shelves

- * Assembly with tool supplied

Ablagen

- * Montage mit Inbusschlüssel

Neon Acrylic Post Caps
Neon Acryl EndKappen

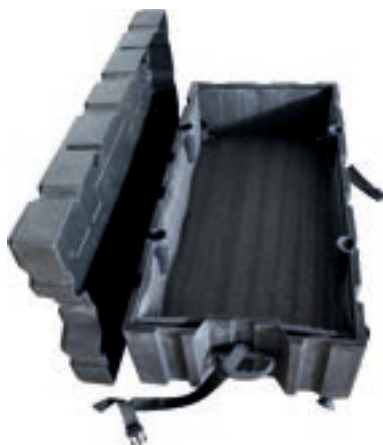

Hard Case for CENTRO
Hartkoffer für CENTRO



CENTRO Graphic bag

- * Hard bag to protect your graphics

CENTRO Grafiktasche

- * Harte Tasche für Ihre Grafiken zu schützen

CENTRO Headers & Wings | CENTRO Topschilder & Flügel

Indoor - Innenbereich

- 🇬🇧 * You can use any shape of headers and wings to expand your stand
- * Cut off what you dream, expand your stand with headers and wings by using our screw clips !..
- * Usable material; Acrylic (perspex), foam PVC, aluminium composite, PP atc

- 🇩🇪 * Sie können jede Form von Topschilder und Flügeln verwenden, um Ihren Stand zu erweitern
- * Schneiden Sie, was Sie träumen, erweitern Sie Ihren Stand mit Topschilder und Flügeln mit besonderen Schraubklemmen!..
- * Verwendbares Material; Acryl, Schaumstoff PVC, Aluminium-Verbundwerkstoff, PP

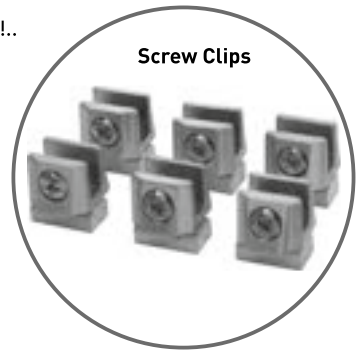

Other Profiles for Modular Exhibition Stands

Andere Profile für Modular Messestände



90 x 16 mm
wide frame profile



90 x 16 mm
breit Strahlprofil

100 x 100 mm
8 way post profile

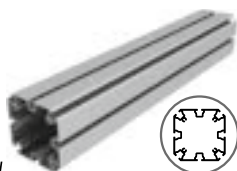

100 x 100 mm
8-Fach Pfostenprofil

25 x 16 mm
connection profile



25 x 16 mm
Strahlprofil

60 x 70 mm
2 way post profile

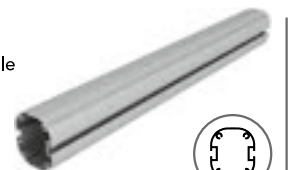

60 x 70 mm
2-Fach Pfostenprofil

Ø 80 mm
1 way post profile
Ø 80 mm
1-Fach Pfostenprofil



35 x 80 mm
dynamic post profile

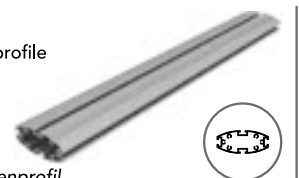

35 x 80 mm
Dynamic Pfostenprofil

Patented

www.centrodisplay.com

Roll Up Banner | Roll-Up Banner



Indoor - Innenbereich



- * Silver anodised aluminium structure in E6/EV1.
- * Foldable legs and collapsible pole for easy transportation.
- * Suitable for single sided use.
- * 2000 mm height graphic display and various width options.
- * Canvas carry bag included.



- * Silber eloxierte Aluminiumstruktur in E6/EV1.
- * Faltbare Beine und zusammenklappbare Stange für einfachen Transport.
- * Für einseitige Anwendung geeignet.
- * 2000 mm hohes Grafikdisplay und verschiedene Breitenoptionen.
- * Inklusive Tragetasche aus Segeltuch.

EXTRUSION: SILVER COLOR (ANODIZED) ALUMINIUM

ITEM CODE	VISIBLE AREA	POSTER SIZE
ROLLUP E 085200	850 x 2000 mm	850 x 2100 mm
ROLLUP STD 080200	800 x 2000 mm	800 x 2100 mm
ROLLUP STD 085200	850 x 2000 mm	850 x 2100 mm
ROLLUP STD 100200	1000 x 2000 mm	1000 x 2100 mm



Eco Banner | Eco Banner



- * Silver anodised aluminium top and bottom graphic holder profiles in E6/EV1.
- * Suitable for single sided use.
- * 18x20 mm elliptical profile leg.
- * 14 mm in diameter collapsible pole for saving space.
- * 2000 mm graphic height and various width options.
- * Canvas carry bag included. Optional hard carry bag.

- * Obere und untere Grafikhalterprofile aus silber eloxiertem Aluminium in E6/EV1.
- * Für einseitige Anwendung geeignet.
- * Bein aus elliptischem Profil 18x20 mm.
- * Zusammenklappbare Stange mit 14 mm Durchmesser zur Platzersparnis.
- * 2000 mm Grafikhöhe und verschiedene Breitenoptionen.
- * Inklusive Tragetasche aus Segeltuch. Optionale Hartschalentasche.

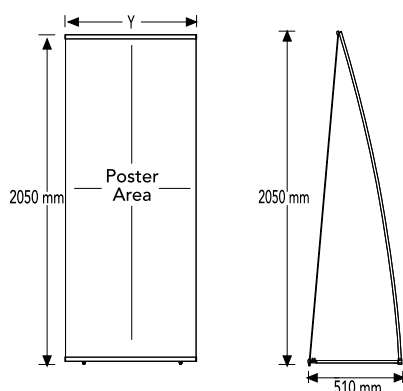

EXTRUSION: SILVER COLOR (ANODIZED) ALUMINIUM

ITEM CODE	POSTER SIZES (Y)	VISIBLE AREA	EXTERNAL SIZE (Y)
EB 060200	600 x 2000 mm	600 x 2000 mm	610 x 2050 mm
EB 070200	700 x 2000 mm	700 x 2000 mm	710 x 2050 mm
EB 080200	800 x 2000 mm	800 x 2000 mm	810 x 2050 mm
EB 100200	1000 x 2000 mm	1000 x 2000 mm	1010 x 2050 mm



ITEM CODE	POSTER SIZES
BAN BAG 90	< 900 mm
BAN BAG 110	900, 1000 mm



Eco Wall

Eco Wall consists of two or more Eco Banner stands joined together and offers a cost-effective, lightweight solution for a larger display area.

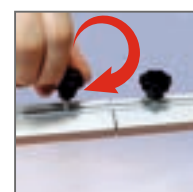
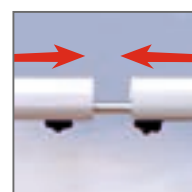
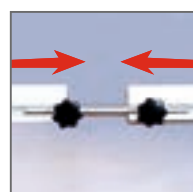
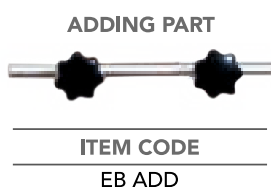

Board Pincher I Board Pincher

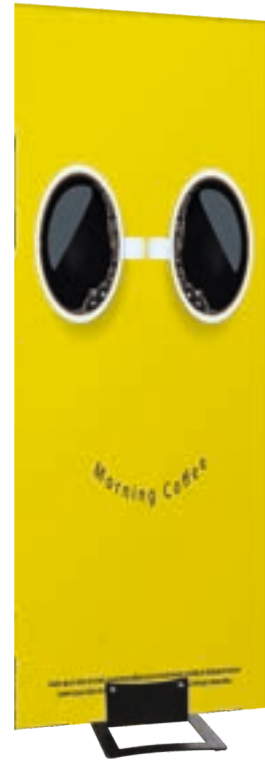

Indoor - Innenbereich

-  * 4 mm thick powder-coated steel plate for extra stability.
- * Suitable for double sided use.
- * Flat design.
- * Easy to use clamping system.
- * Suitable for rigid graphics up to 12 kg. in weight, 1800 mm in height, 20 mm thick.
- * All classic RAL colors from the RAL Color System.
- * For larger panels, we recommend using 2 or more Board Pinchers to ensure maximum stability.
- * Different size options.

-  * 4 mm starkes pulverbeschichtetes Stahlblech für zusätzliche Stabilität.
- * Für beidseitigen Einsatz geeignet.
- * Flaches Design.
- * Einfach zu bedienendes Spannsystem.
- * Geeignet für starre Grafiken bis 12 kg. Gewicht, 1800 mm Höhe, 20 mm Dicke.
- * Alle klassischen RAL-Farben aus dem RAL-Farbsystem.
- * Für größere Platten empfehlen wir die Verwendung von 2 oder mehr Board Pinchers, um maximale Stabilität zu gewährleisten.
- * Verschiedene Größenoptionen.

MATERIAL: 4 MM STEEL	
ITEM CODE	EXTERNAL SIZES
BP 300	300 x 405 mm
BP 400	400 x 500 mm

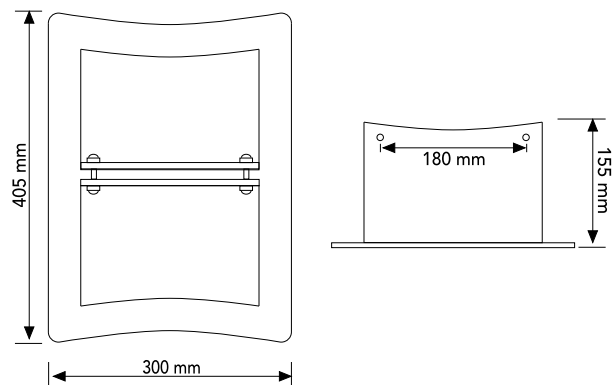

Board Binder I Board Binder



- *  2 mm thick steel plate for extra stability.
- * Suitable for double sided use.
- * Easy use with clamping system.
- * Suitable for rigid graphics up to 12 kg. in weight, 1800 mm in height, 20 mm thick.
- * All classic RAL colors from the RAL Color System.
- * For larger panels, we recommend using 2 or more Board Binders to ensure maximum stability.
- * Different size options.

- *  2 mm dicke Stahlplatte für zusätzliche Stabilität.
- * Für beidseitigen Einsatz geeignet.
- * Einfache Handhabung durch Klemmsystem.
- * Geeignet für starre Grafiken bis 12 kg. Gewicht, 1800 mm Höhe, 20 mm Dicke.
- * Alle klassischen RAL-Farben aus dem RAL-Farbsystem.
- * Bei größeren Platten empfehlen wir die Verwendung von 2 oder mehr Plattenbindern, um maximale Stabilität zu gewährleisten.
- * Verschiedene Größenoptionen.

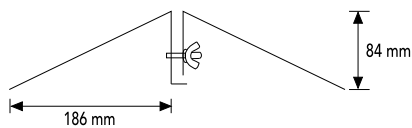

MATERIAL: 2 MM STEEL

ITEM CODE	EXTERNAL SIZES
BB 300	300 x 350 x 100 mm
BB 500	500 x 350 x 100 mm
BB 600	600 x 350 x 100 mm
BB 800	800 x 350 x 100 mm
BB 1000	1000 x 350 x 100 mm



T-Frame | T-Frame



Indoor - Innenbereich

-  * Silver anodised aluminium tube profiles in E6/EV1.
- * Shaped steel base plate for maximum stability.
- * Silicone sewn edges to top and bottom of fabric.
- * High portability: Pick and go display unit.
- * Easy Silicone Edge Graphics (SEG) presentation by tucking into profiles.
- * Unique design tool-free tension banner display.

-  * Silber eloxierte Alu-Rohrprofile in E6/EV1.
- * Geformte Bodenplatte aus Stahl für maximale Stabilität.
- * Mit Silikon genähte Kanten an Ober- und Unterseite des Stoffes.
- * Hohe Portabilität: Pick-and-Go-Anzeigeeinheit.
- * Einfache Präsentation von Silikonkantengrafiken (SEG) durch Einstecken in Profile.
- * Spannbanner-Display mit einzigartigem Design ohne Werkzeug.



**MATERIAL: STEEL BASE
& ALUMINUM TUBE FRAME**

ITEM CODE

TFRAME 60200

TFRAME 70200

TFRAME 80200

TFRAME 90200

TFRAME 100200

"Innovation in display world"



Pop-up Straight I Pop-up Straight



-  * Quickest and Easy classic pop up stand system.
- * Silver anodised aluminium box body profiles in E6/EV1.
- * Straight design.
- * Strengthened support bars for extra stability .
- * Frame consists of square scissors for extra stability and strength
- * Tool-free assembly and quick to disassemble
- * Magnetic graphic fittings for stability and ease.
- * Various size options.

-  * Schnellstes und einfachstes klassisches Pop-Up-Ständersystem.
- * Silber eloxierte Alu-Kofferprofile in E6/EV1.
- * Geradliniges Design.
- * Verstärkte Stützstangen für zusätzliche Stabilität.
- * Der Rahmen besteht aus einer quadratischen Schere für zusätzliche Stabilität und Stärke
- * Werkzeuglose Montage und schnelle Demontage
- * Magnetische Grafikbefestigungen für Stabilität und Leichtigkeit.
- * Verschiedene Größenoptionen.

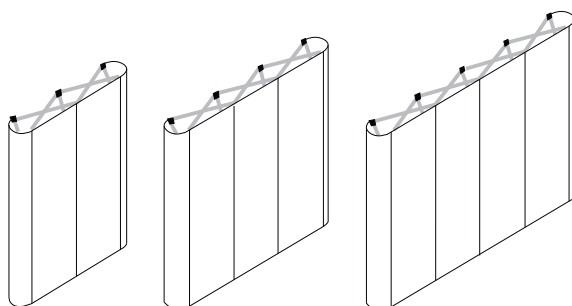
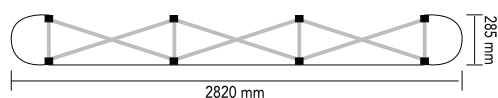
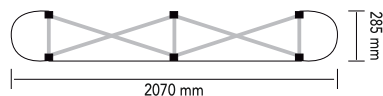

ITEM CODE
ORM 1x3 D
ORM 2x3 D
ORM 3x3 D
ORM 4x3 D
ORM 5x3 D

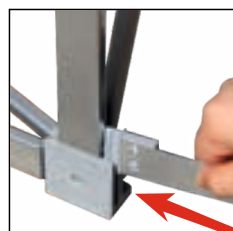
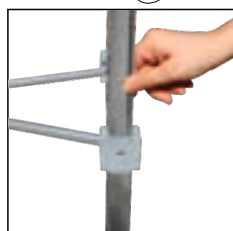
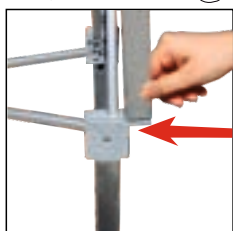

Pop-up Curve I *Pop-up Curve*



Indoor - Innenbereich

-  * Silver anodised aluminium rectangular body profiles in E6/EV1.
- * Curved design.
- * Strengthened support bars for extra stability
- * Frame consists of square scissors for extra stability and strength.
- * Tool-free assembly and quick to disassemble.
- * Magnetic display system, especially designed for large graphics.
- * Various size options.

-  * Silber eloxierte Aluminium-Rechteckkorpusprofile in E6/EV1.
- * Geschwungenes Design.
- * Verstärkte Stützstangen für zusätzliche Stabilität
- * Der Rahmen besteht aus einer quadratischen Schere für zusätzliche Stabilität und Stärke.
- * Werkzeuglose Montage und schnelle Demontage.
- * Magnetisches Anzeigesystem, speziell entwickelt für große Grafiken.
- * Verschiedene Größenoptionen.

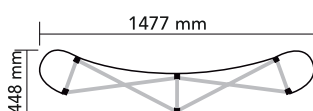
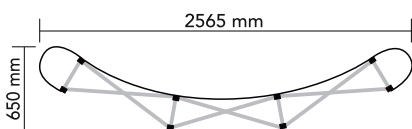
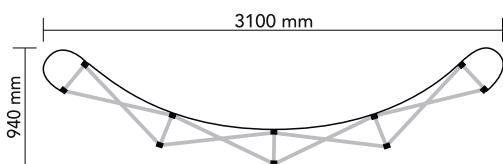
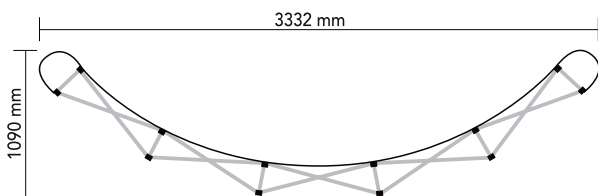

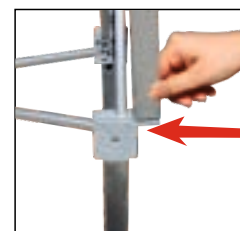
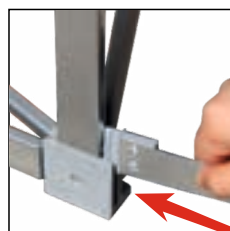

ITEM CODE
ORM 2x3 E
ORM 3x3 E
ORM 4x3 E
ORM 5x3 E



Pop-up Textile | Pop-up Textil



-  * Made of silver anodised aluminium, lightweight tube profiles in E6/EV1.
- * Manufactured for using large format textile printed media.
- * Large display area for textile visuals and small area required for storage.
- * Suitable for single and double sided use.
- * Supportive strengthen plastic connectors and steel parts.
- * No tools needed for installation. Interlock system.
- * 3000x3000 mm. and 3000x4000 mm. dimension options.

-  * Aus silber eloxiertem Aluminium, leichte Rohrprofile in E6/EV1.
- * Hergestellt für die Verwendung großformatiger Textildruckmedien.
- * Große Ausstellungsfläche für Textil-Visuals und kleiner Platzbedarf für die Aufbewahrung.
- * Für ein- und doppelseitige Anwendung geeignet.
- * Unterstützend verstärken Kunststoffverbinder und Stahlteile.
- * Kein Werkzeug für die Installation erforderlich. Interlock-System.
- * 3000 x 3000 mm. und 3000 x 4000 mm. Dimensionsoptionen.

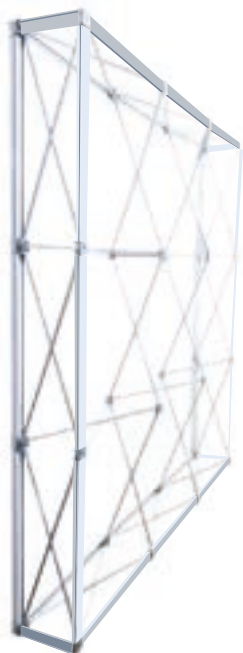

ITEM CODE	SIZE
ORTX 3x3	3000 x 3000 mm
ORTX 4x3	4000 x 3000 mm



Pano Panel I *Faltwand*



Indoor - Innenbereich

-  * Silver anodised aluminium profiles in E6/EV1.
- * PVC Foam sheet printable panels for graphic display.
- * Each panel in 700x1000 mm size. Different number of panel combinations available.
- * Suitable for single and double sided use.
- * Foldable structure.
- * Optional header.
- * 2085 mm in height without header and 2420 mm in height with header.
- * Black fabric carry bag included.

-  * Silber eloxierte Aluminiumprofile in E6/EV1.
- * Bedruckbare Platten aus PVC-Schaumstoff für grafische Darstellungen.
- * Jedes Paneel in der Größe 700x1000 mm. Unterschiedliche Anzahl von Paneelkombinationen erhältlich.
- * Für ein- und doppelseitige Anwendung geeignet.
- * Faltbare Struktur.
- * Optionale Überschrift.
- * 2085 mm hoch ohne Kopfstück und 2420 mm hoch mit Kopfstück.
- * Tragetasche aus schwarzem Stoff inklusive.

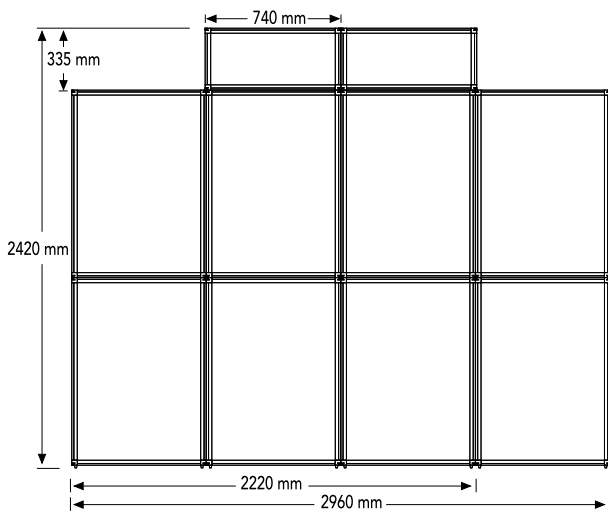

WITHOUT HEADER

EXTRUSION: SILVER COLOR (ANODIZED) ALUMINIUM

ITEM CODE	IMAGE SIZES	VISIBLE AREA
PANO W3 X 2 070100	6 x (700x1000) mm	680 x 980 mm x 6
PANO W4 X 2 070100	8 x (700x1000) mm	680 x 980 mm x 8

WITH HEADER

EXTRUSION: SILVER COLOR (ANODIZED) ALUMINIUM

ITEM CODE	IMAGE SIZES	VISIBLE AREA
PANO W3 X 2 070100 H	6 x (700x1000) mm	680 x 980 mm x 6
PANO W4 X 2 070100 H	8 x (700x1000) mm	680 x 980 mm x 8

HEADER SIZE

1x700x300 mm
2x700x300 mm



Folding Room Divider I *Faltbarer Raumteiler*

Indoor - Innenbereich

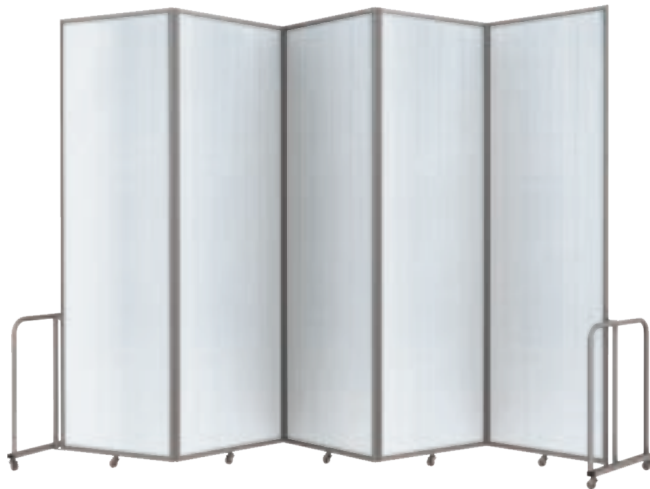

Light Transmissive Panels(FRD1)

EXTRUSION: Silver color (anodized) aluminium	
ITEM CODE	EXTERNAL SIZES
FRD 1	560 x 1905 mm

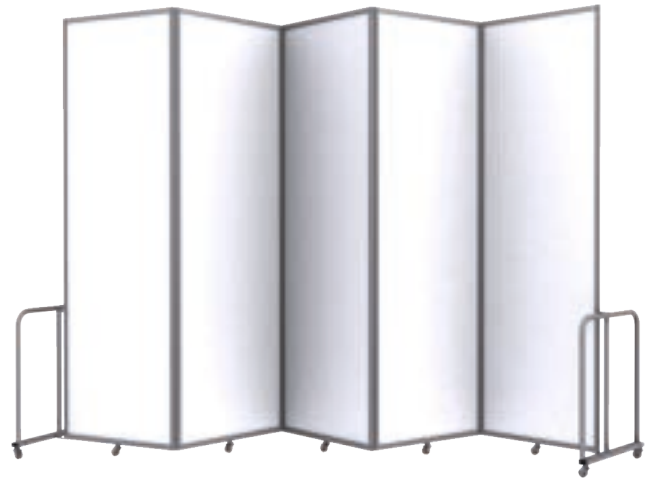

Rigid Panels(FRD3)

EXTRUSION: Silver color (anodized) aluminium	
ITEM CODE	EXTERNAL SIZES
FRD 3	560 x 1905 mm



- * 360 degree hinged profiles allow full rotation of each panel.
- * Easy manipulation and unlimited configurations like zig-zag, L-shape, curve and straight.
- * 360-Grad-Scharnierprofile ermöglichen eine vollständige Drehung der einzelnen Tafeln.
- * Einfache Handhabung und unbegrenzte Konfigurationen wie Zickzack, L-Form, Kurve und gerade.

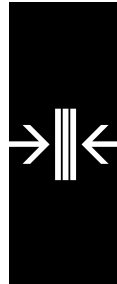

- * Easy to fold and move due to its light weight.
- * Simply stored with folded sizes of 60 cm x 20 cm. Can be rolled easily when its folded.
- * Durch sein geringes Gewicht leicht zu falten und zu bewegen.
- * Einfach zu lagern gefaltete Größe 60 cm x 20 cm. Gefaltet ist es einfach zu rollen.



- * Fluted polycarbonate panels which engineered for sound insulation supply superior acoustic performance
- * Geriffelte Polycarbonat-Platten, die für die Schalldämmung liefern überlegene akustische Leistung



- * Delivered unassembled for less transport costs. Easy to assemble it in 5 minutes.
- * Lieferung unmontiert zwecks geringerer Transportkosten. Einfach in 5 Minuten zu montieren.



- * Polycarbonate panels are %100 waterproof.
- * Polycarbonatplatten sind 100% wasserdicht



- * Safe and user friendly design without pinch-hinged profiles
- * Sicheres und benutzerfreundliches Design ohne Quetschelenkprofile



- * Cleanable panels are ideal for hygienic environments
- * Reinigbare Platten sind ideal für hygienische Umgebungen



- * Company logos and artworks can be directly printed on the panels
- * Firmenlogos und Kunstwerke können direkt auf die Tafeln gedruckt werden

Folding Room Divider I *Faltbarer Raumteiler*







Half Panels

EXTRUSION: Silver color (anodized) aluminium



ITEM CODE	EXTERNAL SIZES
FRD 2	560 x 1905 mm

Indoor - Innenbereich





-  * 360 degree hinged profiles allow full rotation of each panel.
-  * Easy manipulation and unlimited configurations like zig-zag, L-shape, curve and straight.
-  * 360-Grad-Scharnierprofile ermöglichen eine vollständige Drehung der einzelnen Tafeln.
-  * Einfache Handhabung und unbegrenzte Konfigurationen wie Zickzack, L-Form, Kurve und gerade.





-  * Cleanable panels are ideal for hygienic environments
-  * *Reinigbare Platten sind ideal für hygienische Umgebungen*





-  * Company logos and artworks can be directly printed on the panels
-  * *Firmenlogos und Kunstwerke können direkt auf die Tafeln gedruckt werden*







-  * Fluted polycarbonate panels which engineered for sound insulation supply superior acoustic performance
-  * *Geriffelte Polycarbonat-Platten, die für die Schalldämmung liefern überlegene akustische Leistung*

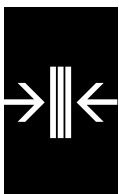



-  * Safe and user friendly design without pinch-hinged profiles
-  * *Sicheres und benutzerfreundliches Design ohne Quetschgelenkprofile*



-  * Easy to fold and move due to its light weight.
-  * Simply stored with folded sizes of 60 cm x 20 cm. Can be rolled easily when its folded.
-  * *Durch sein geringes Gewicht leicht zu falten und zu bewegen.*
-  * *Einfach zu lagern gefaltete Größe 60 cm x 20 cm. Gefaltet ist es einfach zu rollen.*





-  * Delivered unassembled for less transport costs. Easy to assemble it in 5 minutes.
-  * *Lieferung unmontiert zwecks geringerer Transportkosten. Einfach in 5 Minuten zu montieren.*

Tube Folding Room Divider | Rohr Faltpbarer Raumteiler

Indoor - Innenbereich



-  * Steel tube profiles.
- * 4 mm thick white composite panels, each in 600x1360 mm.
- * Three partitions, each in 600x1800 mm.
- * Easy storage with foldable design.
- * Sound and heat insulation.
- * Eight pcs wheels for easy transportation and stability (4 wheels lockable).

-  * Stahlrohrprofile.
- * 4 mm dicke weiße Verbundplatten, jeweils in 600x1360 mm.
- * Drei Trennwände, jeweils in 600x1800 mm.
- * Einfache Lagerung mit faltbarem Design.
- * Schall- und Wärmedämmung.
- * Acht Räder für einfachen Transport und Stabilität (4 Räder feststellbar).

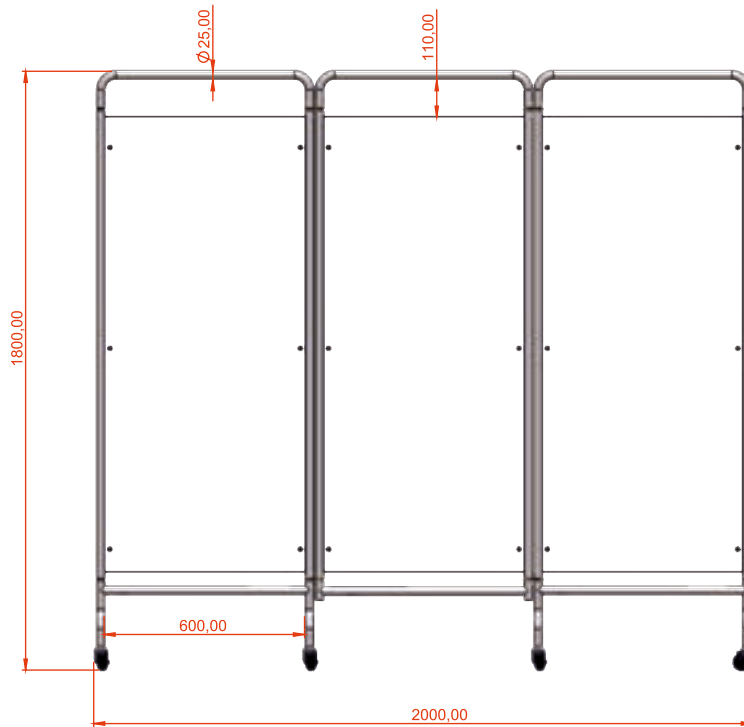

ITEM CODE	SIZE
FRD TUBE	1800 x 2000 mm